

**Immersion / screw-in / duct temperature sensors  
with passive output**

**Patented quality product (Immersion sensor patent no. DE 10 2012 017 500.0)**

**THERMASGARD® TF 43** is a resistance thermometer with a passive output, enclosure made from impact-resistant plastic with snap-on lid, and straight protective tube.

**THERMASGARD® TF 65** is a resistance thermometer with a passive output, enclosure made from impact-resistant plastic with quick-locking screws, and straight protective tube.

These immersion / screw-in / duct temperature sensors are electric contact thermometers for temperature measurement in liquids and gases, which are installed for example in piping systems and vessels. For aggressive media, stainless steel immersion sleeves must be used.

Applications of these temperature sensors in piping systems, in heating technology, in storage tanks, in district heating compact stations, in hot and cold-water systems, in oil and lubricant circulation systems, in mechanical, apparatus and plant engineering as well as in the entire industrial sector.

**TECHNICAL DATA**

Measuring range:	-30...+150 °C (T <sub>max</sub> NTC = +150 °C, T <sub>max</sub> LM235Z = +125 °C)
Sensors / output:	see table, passive ( <b>Perfect Sensor Protection</b> ) (optional also with two sensors)
Connection type:	2-wire connection (4-wire connection on PT100/PT1000A, optional on other sensors)
Testing current:	< 0.6 mA (Pt1000) < 1.0 mA (Pt100) < 0.3 mA (Ni1000, Ni1000 TK5000) < 2.0 mW (NTC xx) 400 µA...5 mA (LM235Z)
Insulating resistance:	≥ 100 MΩ, at +20 °C (500 V DC)
Ambient temperature:	-20...+100 °C
Enclosure:	plastic, UV-stabilised, material polyamide, 30 % glass-globe reinforced, colour traffic white (similar to RAL 9016) <b>TF 43 with snap-on lid</b> <b>TF 65 with quick-locking screws</b> (slotted / Phillips head combination)
Enclosure dimensions:	72 x 64 x 37.8 mm (Tyr 1 / Tyr 01)
Cable gland:	M 16 x 1,5; including strain relief, exchangeable, max. inner diameter 10,4 mm
Electrical connection:	0.14 - 1.5 mm <sup>2</sup> , via terminal screws
Protective tube:	stainless steel, <b>V4A</b> (1.4571), Ø = 6 mm, inserted length (EL) = 50-400 mm (see table)
Permissible humidity:	< 95 % r. H., non-precipitating air
Protection class:	III (according to EN 60 730)
Protection type:	<b>TF 43 IP 43</b> (according to EN 60 529) <b>TF 65 IP 65</b> (according to EN 60 529)

**ACCESSORIES**

<b>MF-15-K</b>	<b>Mounting flange</b> , plastic, 56.8 x 84.3 mm, Ø = 15,2 mm tube gland, T <sub>max</sub> = +100 °C
<b>TH08-ms/xx</b>	<b>Immersion sleeve</b> , brass, nickel-plated, Ø = 8 mm, T <sub>max</sub> = +150 °C, p <sub>max</sub> = 10 bar
<b>TH08-VA/xx</b>	<b>Immersion sleeve</b> , stainless steel, <b>V4A</b> (1.4571), Ø = 8 mm, T <sub>max</sub> = +600 °C, p <sub>max</sub> = 40 bar
<b>TH08-VA/xx/90</b>	<b>Immersion sleeve</b> , stainless steel, <b>V4A</b> (1.4571), with neck tube (90 mm), Ø = 8 mm, T <sub>max</sub> = +600 °C, p <sub>max</sub> = 40 bar

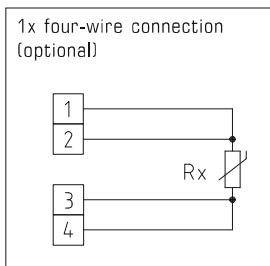
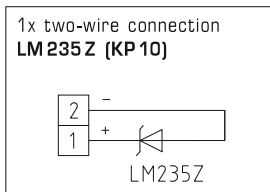
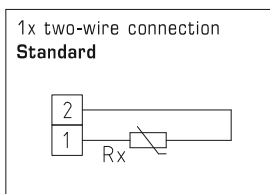

High-performance encapsulation against  
vibration, mechanical stress and humidity





S+S REGELTECHNIK

THERMASGARD® TF 43  
THERMASGARD® TF 65

Immersion / screw-in / duct temperature sensors  
with passive output

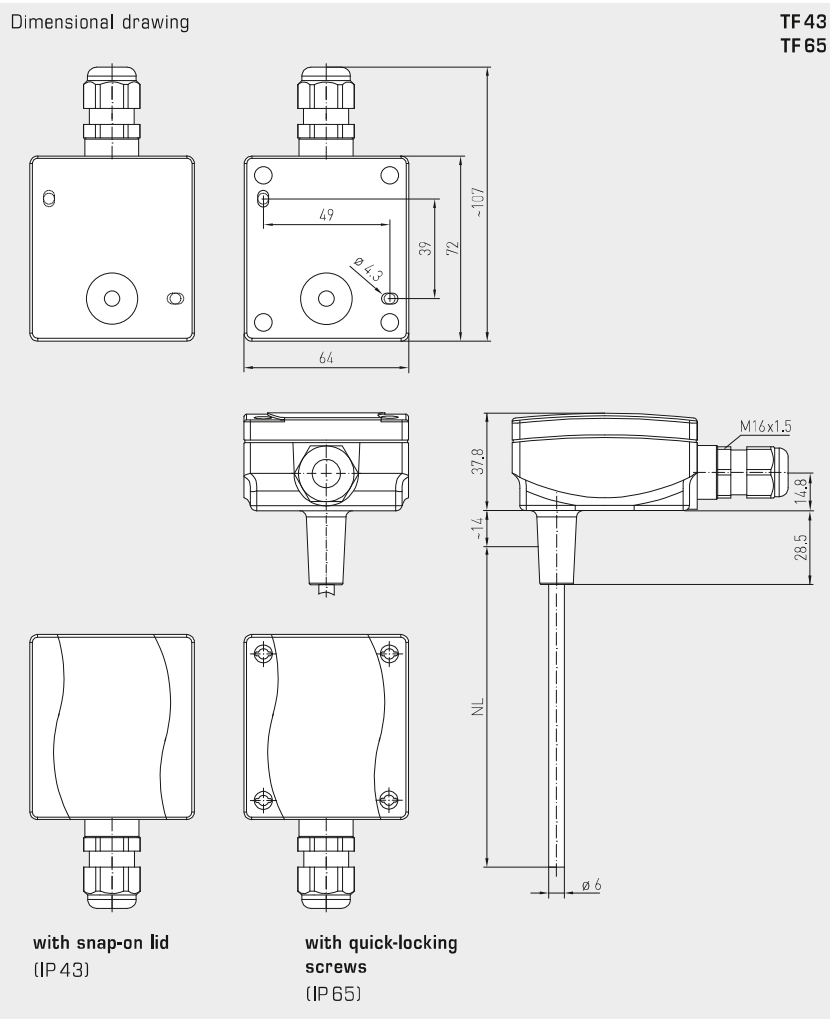

TF 43  
with snap-on lid  
(IP 43)



TF 65  
with quick-locking screws  
(IP 65)



**PATENTED**



TFxx  
Basic device  
with accessories

**THERMASGARD® TF 43** Temperature sensors (Basic device with snap-on lid), *Standard*

Type / WG03 / EL	Sensor / Output	Item No.	Price
<b>TF43 PT100 xx</b>	<b>Pt100</b>	<b>IP43</b>	
TF43 PT100 50MM	Pt100 (according to DIN EN 60 751, class B)	1101-7010-1013-000	<b>23,84 €</b>
TF43 PT100 100MM	Pt100 (according to DIN EN 60 751, class B)	1101-7010-1023-000	<b>23,95 €</b>
TF43 PT100 150MM	Pt100 (according to DIN EN 60 751, class B)	1101-7010-1033-000	<b>24,70 €</b>
TF43 PT100 200MM	Pt100 (according to DIN EN 60 751, class B)	1101-7010-1043-000	<b>25,40 €</b>
TF43 PT100 250MM	Pt100 (according to DIN EN 60 751, class B)	1101-7010-1053-000	<b>26,69 €</b>
TF43 PT100 300MM	Pt100 (according to DIN EN 60 751, class B)	1101-7010-1063-000	<b>28,89 €</b>
TF43 PT100 350MM	Pt100 (according to DIN EN 60 751, class B)	1101-7010-1073-000	<b>29,78 €</b>
TF43 PT100 400MM	Pt100 (according to DIN EN 60 751, class B)	1101-7010-1083-000	<b>30,72 €</b>
<b>TF43 PT1000 xx</b>	<b>Pt1000</b>	<b>IP43</b>	
TF43 PT1000 50MM	Pt1000 (according to DIN EN 60 751, class B)	1101-7010-5011-000	<b>23,84 €</b>
TF43 PT1000 100MM	Pt1000 (according to DIN EN 60 751, class B)	1101-7010-5021-000	<b>23,95 €</b>
TF43 PT1000 150MM	Pt1000 (according to DIN EN 60 751, class B)	1101-7010-5031-000	<b>24,70 €</b>
TF43 PT1000 200MM	Pt1000 (according to DIN EN 60 751, class B)	1101-7010-5041-000	<b>25,40 €</b>
TF43 PT1000 250MM	Pt1000 (according to DIN EN 60 751, class B)	1101-7010-5051-000	<b>26,69 €</b>
TF43 PT1000 300MM	Pt1000 (according to DIN EN 60 751, class B)	1101-7010-5061-000	<b>28,89 €</b>
TF43 PT1000 350MM	Pt1000 (according to DIN EN 60 751, class B)	1101-7010-5071-000	<b>29,78 €</b>
TF43 PT1000 400MM	Pt1000 (according to DIN EN 60 751, class B)	1101-7010-5081-000	<b>30,72 €</b>
<b>TF43 Ni1000 xx</b>	<b>Ni 1000</b>	<b>IP43</b>	
TF43 Ni1000 50MM	Ni1000 (according to DIN EN 43 760, class B, TCR = 6180 ppm / K)	1101-7010-9011-000	<b>24,44 €</b>
TF43 Ni1000 100MM	Ni1000 (according to DIN EN 43 760, class B, TCR = 6180 ppm / K)	1101-7010-9021-000	<b>26,74 €</b>
TF43 Ni1000 150MM	Ni1000 (according to DIN EN 43 760, class B, TCR = 6180 ppm / K)	1101-7010-9031-000	<b>26,95 €</b>
TF43 Ni1000 200MM	Ni1000 (according to DIN EN 43 760, class B, TCR = 6180 ppm / K)	1101-7010-9041-000	<b>27,54 €</b>
TF43 Ni1000 250MM	Ni1000 (according to DIN EN 43 760, class B, TCR = 6180 ppm / K)	1101-7010-9051-000	<b>28,30 €</b>
TF43 Ni1000 300MM	Ni1000 (according to DIN EN 43 760, class B, TCR = 6180 ppm / K)	1101-7010-9061-000	<b>30,18 €</b>
TF43 Ni1000 350MM	Ni1000 (according to DIN EN 43 760, class B, TCR = 6180 ppm / K)	1101-7010-9071-000	<b>31,02 €</b>
TF43 Ni1000 400MM	Ni1000 (according to DIN EN 43 760, class B, TCR = 6180 ppm / K)	1101-7010-9081-000	<b>32,43 €</b>
<b>TF43 Ni1000TK xx</b>	<b>Ni1000 TK5000</b>	<b>IP43</b>	
TF43 NITK 50MM	Ni1000 TK5000 (TCR = 5000 ppm / K), LG-Ni1000	1101-7011-0011-000	<b>24,48 €</b>
TF43 NITK 100MM	Ni1000 TK5000 (TCR = 5000 ppm / K), LG-Ni1000	1101-7011-0021-000	<b>26,80 €</b>
TF43 NITK 150MM	Ni1000 TK5000 (TCR = 5000 ppm / K), LG-Ni1000	1101-7011-0031-000	<b>27,07 €</b>
TF43 NITK 200MM	Ni1000 TK5000 (TCR = 5000 ppm / K), LG-Ni1000	1101-7011-0041-000	<b>27,65 €</b>
TF43 NITK 250MM	Ni1000 TK5000 (TCR = 5000 ppm / K), LG-Ni1000	1101-7011-0051-000	<b>28,40 €</b>
TF43 NITK 300MM	Ni1000 TK5000 (TCR = 5000 ppm / K), LG-Ni1000	1101-7011-0061-000	<b>30,29 €</b>
TF43 NITK 350MM	Ni1000 TK5000 (TCR = 5000 ppm / K), LG-Ni1000	1101-7011-0071-000	<b>31,24 €</b>
TF43 NITK 400MM	Ni1000 TK5000 (TCR = 5000 ppm / K), LG-Ni1000	1101-7011-0081-000	<b>32,54 €</b>

Continued on next page...

High-performance encapsulation against  
vibration, mechanical stress and humidity





THERMASGARD® TF 43 Temperature sensors (Basic device with snap-on lid), Standard			
Type / WG03 / EL	Sensor / Output	Item No.	Price
<b>TF43 LM235Z xx</b>	<b>LM235Z</b>	<b>IP43</b>	
TF43 LM235Z 50MM	LM235Z (TCR = 10 mV / K; 2,73 V at 0 °C), KP10	1101-7012-1011-000	24,92 €
TF43 LM235Z 100MM	LM235Z (TCR = 10 mV / K; 2,73 V at 0 °C), KP10	1101-7012-1021-000	25,18 €
TF43 LM235Z 150MM	LM235Z (TCR = 10 mV / K; 2,73 V at 0 °C), KP10	1101-7012-1031-000	26,10 €
TF43 LM235Z 200MM	LM235Z (TCR = 10 mV / K; 2,73 V at 0 °C), KP10	1101-7012-1041-000	26,69 €
TF43 LM235Z 250MM	LM235Z (TCR = 10 mV / K; 2,73 V at 0 °C), KP10	1101-7012-1051-000	27,00 €
TF43 LM235Z 300MM	LM235Z (TCR = 10 mV / K; 2,73 V at 0 °C), KP10	1101-7012-1061-000	29,32 €
TF43 LM235Z 350MM	LM235Z (TCR = 10 mV / K; 2,73 V at 0 °C), KP10	1101-7012-1071-000	29,67 €
TF43 LM235Z 400MM	LM235Z (TCR = 10 mV / K; 2,73 V at 0 °C), KP10	1101-7012-1081-000	31,52 €
<b>TF43 NTC 1.8K xx</b>	<b>NTC 1.8K</b>	<b>IP43</b>	
TF43 NTC1,8K 50MM	NTC 1.8K	1101-7011-2011-000	23,84 €
TF43 NTC1,8K 100MM	NTC 1.8K	1101-7011-2021-000	25,13 €
TF43 NTC1,8K 150MM	NTC 1.8K	1101-7011-2031-000	25,77 €
TF43 NTC1,8K 200MM	NTC 1.8K	1101-7011-2041-000	26,37 €
TF43 NTC1,8K 250MM	NTC 1.8K	1101-7011-2051-000	27,65 €
TF43 NTC1,8K 300MM	NTC 1.8K	1101-7011-2061-000	28,56 €
TF43 NTC1,8K 350MM	NTC 1.8K	1101-7011-2071-000	29,52 €
TF43 NTC1,8K 400MM	NTC 1.8K	1101-7011-2081-000	30,29 €
<b>TF43 NTC10K xx</b>	<b>NTC 10K</b>	<b>IP43</b>	
TF43 NTC10K 50MM	NTC 10K	1101-7011-5011-000	23,84 €
TF43 NTC10K 100MM	NTC 10K	1101-7011-5021-000	25,13 €
TF43 NTC10K 150MM	NTC 10K	1101-7011-5031-000	25,77 €
TF43 NTC10K 200MM	NTC 10K	1101-7011-5041-000	26,37 €
TF43 NTC10K 250MM	NTC 10K	1101-7011-5051-000	27,65 €
TF43 NTC10K 300MM	NTC 10K	1101-7011-5061-000	28,56 €
TF43 NTC10K 350MM	NTC 10K	1101-7011-5071-000	29,52 €
TF43 NTC10K 400MM	NTC 10K	1101-7011-5081-000	30,29 €
<b>TF43 NTC20K xx</b>	<b>NTC 20K</b>	<b>IP43</b>	
TF43 NTC20K 50MM	NTC 20K	1101-7011-6011-000	23,84 €
TF43 NTC20K 100MM	NTC 20K	1101-7011-6021-000	25,13 €
TF43 NTC20K 150MM	NTC 20K	1101-7011-6031-000	25,77 €
TF43 NTC20K 200MM	NTC 20K	1101-7011-6041-000	26,37 €
TF43 NTC20K 250MM	NTC 20K	1101-7011-6051-000	27,65 €
TF43 NTC20K 300MM	NTC 20K	1101-7011-6061-000	28,56 €
TF43 NTC20K 350MM	NTC 20K	1101-7011-6071-000	29,52 €
TF43 NTC20K 400MM	NTC 20K	1101-7011-6081-000	30,29 €
Note	Other sensors optional	on request	

TF43  
with snap-on lid  
(IP43)

**Immersion / screw-in / duct temperature sensors  
 with passive output**

**One basic device in four variants...**



**PATENTED**

**TFxx +  
 TH08-ms/xx**

Immersion / screw-in  
 temperature sensor  
 with immersion sleeve,  
 brass, nickel-plated

**TFxx +  
 TH08-VA/xx**

Immersion / screw-in  
 temperature sensor  
 with immersion sleeve,  
 stainless steel, V4A

**TFxx +  
 TH08-VA/xx/90**

Immersion / screw-in  
 temperature sensor with  
 immersion sleeve with neck  
 tube, stainless steel, V4A

**TFxx +  
 MF-15-K**

Duct temperature sensor  
 with mounting flange, plastic

Dimensional drawing  
**TH08-ms/xx**

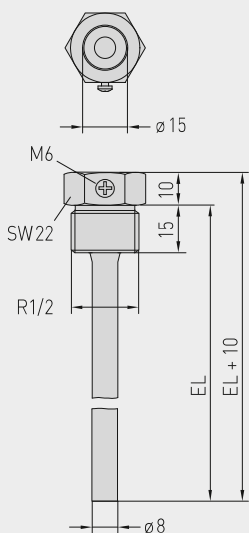

Dimensional drawing  
**TH08-VA/xx**

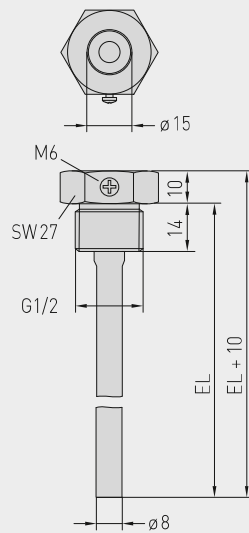

Dimensional drawing  
**TH08-VA/xx/90**

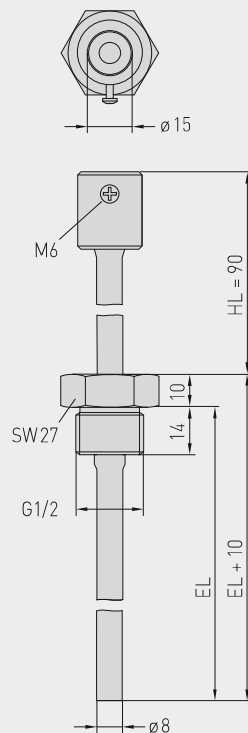

Dimensional drawing  
**MF-15-K**

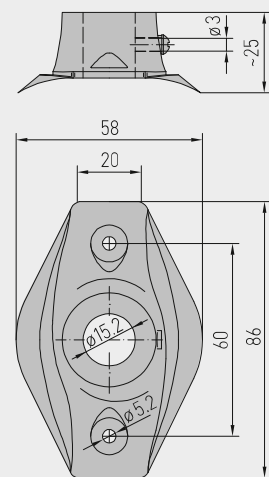



...through combination with accessories:



**TH08-ms/xx**  
Immersion sleeve,  
brass, nickel-plated,  
thread-sealing, conical,  
according to DIN 10226



**TH08-VA/xx**  
Immersion sleeve,  
stainless steel, V4A,  
flat-sealing, cylindrical,  
according to DIN 228



**TH08-VA/xx/90**  
Immersion sleeve with neck tube,  
stainless steel, V4A,  
flat-sealing, cylindrical,  
according to DIN 228



**MF-15-K**  
Mounting flange,  
plastic

THERMASGARD® TH08 Immersion sleeve Ø 8 mm (Accessories)					
Type / WG01B	p <sub>max</sub> (static)	T <sub>max</sub>	Inserted Length (EL)	Item No.	Price
<b>TH08-ms/xx</b> Brass, nickel-plated					
without neck tube					
TH08-MS 50MM	10 bar	+150 °C	50 mm	7100-0011-0010-132	7,85 €
TH08-MS 100MM	10 bar	+150 °C	100 mm	7100-0011-0020-132	8,95 €
TH08-MS 150MM	10 bar	+150 °C	150 mm	7100-0011-0030-132	9,45 €
TH08-MS 200MM	10 bar	+150 °C	200 mm	7100-0011-0040-132	9,75 €
TH08-MS 250MM	10 bar	+150 °C	250 mm	7100-0011-0050-132	11,30 €
TH08-MS 300MM	10 bar	+150 °C	300 mm	7100-0011-0060-132	11,60 €
TH08-MS 350MM	10 bar	+150 °C	350 mm	7100-0011-0070-132	11,70 €
TH08-MS 400MM	10 bar	+150 °C	400 mm	7100-0011-0080-132	11,80 €
<b>TH08-VA/xx</b> Stainless steel, V4A (1.4571)					
without neck tube					
TH08-VA 50MM	40 bar	+600 °C	50 mm	7100-0012-0010-132	17,10 €
TH08-VA 100MM	40 bar	+600 °C	100 mm	7100-0012-0020-132	18,90 €
TH08-VA 150MM	40 bar	+600 °C	150 mm	7100-0012-0030-132	20,30 €
TH08-VA 200MM	40 bar	+600 °C	200 mm	7100-0012-0040-132	21,40 €
TH08-VA 250MM	40 bar	+600 °C	250 mm	7100-0012-0050-132	26,60 €
TH08-VA 300MM	40 bar	+600 °C	300 mm	7100-0012-0060-132	27,80 €
TH08-VA 350MM	40 bar	+600 °C	350 mm	7100-0012-0070-132	28,00 €
TH08-VA 400MM	40 bar	+600 °C	400 mm	7100-0012-0080-132	28,50 €
<b>TH08-VA/xx/90</b> Stainless steel, V4A (1.4571)					
with neck tube (90 mm)					
TH08-VA 50/90MM	40 bar	+600 °C	50 mm	7100-0012-0012-132	24,50 €
TH08-VA 100/90MM	40 bar	+600 °C	100 mm	7100-0012-0022-132	25,60 €
TH08-VA 150/90MM	40 bar	+600 °C	150 mm	7100-0012-0032-132	26,85 €
TH08-VA 200/90MM	40 bar	+600 °C	200 mm	7100-0012-0042-132	28,00 €
TH08-VA 250/90MM	40 bar	+600 °C	250 mm	7100-0012-0052-132	29,35 €
TH08-VA 300/90MM	40 bar	+600 °C	300 mm	7100-0012-0062-132	31,80 €
Note: inner diameter of socket 15,0 mm For further information see last chapter!					
Mounting flange (Accessories)					
Type / WG01B		T <sub>max</sub>	Item No.	Price	
<b>MF</b>					
MF-15-K	Mounting flange, plastic, 56,8x84,3 mm, Ø 15,2 mm tube gland	+100 °C	7100-0032-0000-000	5,16 €	
Note: For further information see last chapter!					