

**2-phase frost protection thermostat,
with control and cascading input,
with active and switching output**

FS-20

Electronic frost protection thermostat / frost monitor **THERMASREG® FS-20** with switching relay output, continuous temperature and valve output (summation output 0–10V) and control and cascading output (0–10V), optionally with connection for heating element, in an impact-resistant plastic housing with quick-locking screws, with display by default, with fully active sensorrod made from copper.

The frost monitor is used to monitor air conditioning systems, heat exchangers, heating registers and similar systems, and protects against frost damage and freezing. Falling below the limit value is detected at the coldest measuring point of the capillary tube, the sensor rod is active along its entire length. Uses internal diagnostics to detect capillary breakage, power failure or electric damage to the sensor as an error and the relay automatically switches to frost.

The innovative 2-phase frost protection thermostat enables simple combination of several devices (cascading) for demand-oriented, comprehensive frost monitoring. The delivery scope includes the mounting clamps **MK-05-K** for expert attachment of the sensor rod.



TECHNICAL DATA

Power supply:	24 V AC / DC (± 10 %)
Load resistance:	$R_L > 50 \text{ k}\Omega$
Measuring range:	0...+15 °C
Input:	1 x 0-10V control input DDC 1 x 0-10V ascading input
Output:	1 x 0-10V output temperature (corresponding to 0...+15 °C) 1 x 0-10V output valve (frost signal with control voltage and cascading) 1 x potential-free changeover contact (24 V), range of adjustment 0...+15 °C
Current consumption:	max. 100 mA at 24 V DC (FS-20 without heating element) max. 200 mA at 24 V DC (FS-20 xx HE with heating element)
Accuracy:	typically ± 1 K (at +10 °C)
Hysteresis of the switch step:	2K
Turn-on/run-in time :	< 1 min
Response time:	$t_{90} < 5 \text{ s}$
Sensor and capillary tube:	Copper sensor rod, length of 3 m or 6 m, active along the entire sensor length, min. response length of 25 cm
Ambient temperatures:	Sensor and capillary tube: -20...+60 °C (capillary tube at a distance of >20 cm from the housing) Housing: -15...+50 °C Storage/transport: -30...+70 °C
Housing:	plastic, UV-resistant, material polyamide, 30 % glass-globe reinforced, with quick-locking screws (slotted / Phillips head combination), colour traffic white (similar to RAL 9016), housing cover for display is transparent!
Housing dimensions:	126 x 90 x 50 mm (Tyr 2)
Cable gland:	M 16 x 1.5 ; including strain relief, exchangeable, max. inner diameter 10.4 mm
Process connection:	by mounting clamps MMK-05-K (included in the scope of delivery)
Electrical connection:	0.14 - 1.5 mm ² , via screw terminals
Routing:	bending radius > 35mm admissible vibration load ≤ ½g admissible tensile load < 100N
Permitted humidity:	< 95 % RH, non-precipitating air
Protection class:	III (according to EN 60 730)
Protection type:	IP 65 (according to EN 60529)
Standards:	CE-conformity according to EMC directive 2014 / 30 / EU
Equipment:	display with illumination , three-line, cutout approx. 70 x 40 mm (W x H), for displaying the actual temperature, measuring range overrange/underrange of the set switch point (frost protection temperature), and alarm indicator for "frost" or "error" (capillary breakage, overvoltage/undervoltage)
Internal diagnostics:	Error 1 in case of cable / capillary breakage Error 2 in case of undervoltage / overvoltage (relay automatically switches to frost)



S+S REGELTECHNIK

THERMASREG® FS-20

2-phase frost protection thermostat,
with control and cascading input,
with active and switching output

Dimensional drawing

FS-20

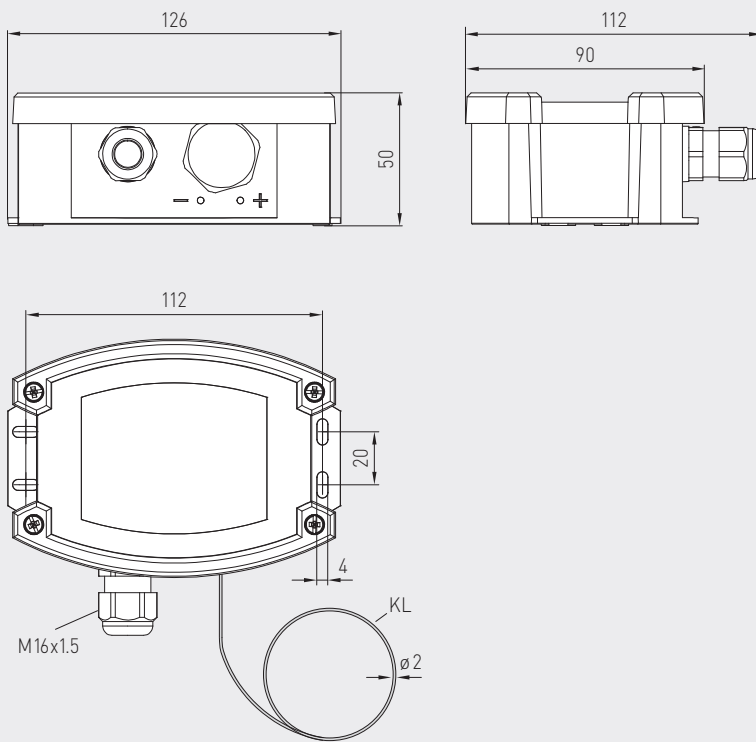

Dimensional drawing

KRD-04

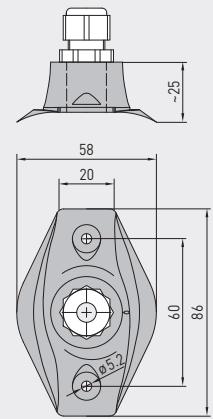

Dimensional drawing

MK-05-K

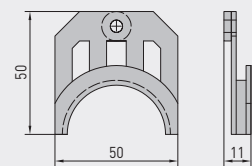

WS-03

Weather and sun protection hood
(optional)



MK-05-K



KRD-04



**2-phase frost protection thermostat,
with control and cascading input,
with active and switching output**

FUNCTION

The filling used in the copper capillary tube in the frost protection monitor generates a pressure signal that is proportional to the lowest temperature on the entire capillary tube (but min. 200mm). This is converted into an electrical signal by a sensor and electronically amplified. The standard signal 0-10V generated as a result corresponding to 0...+15°C is issued. This voltage is available at the "Temp." terminal.

The internal potentiometer can be used to specify a **frost switchpoint "FS"** for the potential-free changeover contact in the range from 0°C (left limit stop) to +15°C (right limit stop). If this switchpoint "FS" is undershot, the relay output switches to the "frost protection" position (contact "W" connected to contact "Ö"). If the temperature rises by more than 2K above the set switchpoint "FS", the device switches back to normal operating mode if **"Reset Auto"** is selected. The relay drops out to the initial position (contact "W" connected to contact "S"). If the **"Reset Hand"** operating mode is selected, the relay output does not automatically switch even if the set switchpoint "FS" +2K is exceeded, but must be manually reset from the **reset button**.

In addition, a second voltage output "AV", mapped by 0-10V, is available. At a voltage of 0V at the control input "SE", the output voltage "AV" is always 0V if the measured temperature is at least 6K above the set switchpoint "FS". If the measured temperature falls below the set switchpoint "FS"+6K, the voltage output "AV" increases in a linear fashion from 0V to 10V. The increase here amounts to 1.67 V for every degree Kelvin by which the temperature approaches the preset switchpoint "FS". The output voltage 10V is therefore issued at "FS" = measured temperature. If you increase "SE", the output voltage "AV" is increased by this amount. The "AV" output therefore represents a summation output for the input variables "SE" and "Frost signal". In this case, the "Frost signal" variable describes the output behaviour of "AV" at "SE" = 0V. The maximum output voltage is restricted to 10V.

Several frost protection devices can be connected to each other via the **cascading input "KE"** to cover a larger channel cross-section for frost monitoring. The AV output of the first device is connected to the KE input of the second device. The internal device logic decides on the priority frost signal of both devices for controlling the heating register valve.

In the event of capillary breakage, electrical sensor damage (cable breakage), voltage failure, falling short of the permissible voltage level or exceeding it, the relay output is automatically switched to "Frost protection" (contact "W" connected to contact "Ö").

NOTE

The capillary tube must be securely seated in the socket and must not twist.
A redundant setup to protect critical systems is **absolutely necessary**.

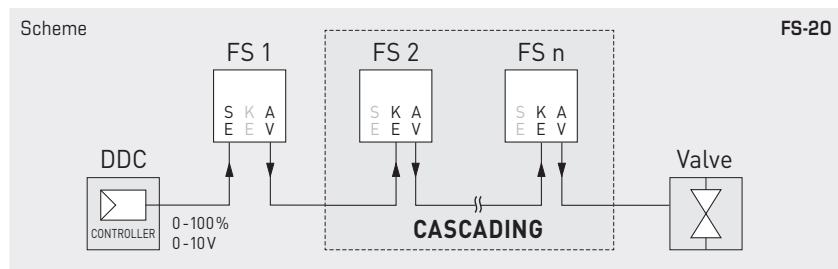

Display readout

FS-20

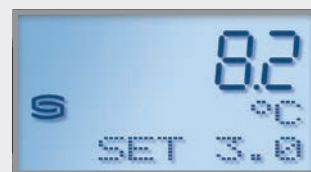

Normal operation

Actual temperature and set switchpoint temperature

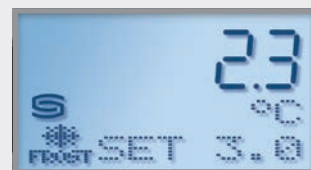

Frost protection alarm

Actual temperature is below switchpoint temperature

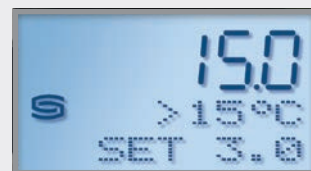

Measuring range exceeded

Actual temperature rises above +15°C

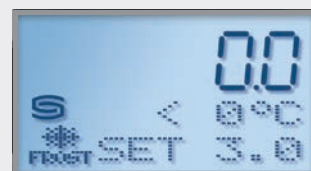

Measuring range underranged

Actual temperature falls below 0°C

1 ERROR Error message 1 in case of cable/capillary breakage

2 ERROR Error message 2 in case of undervoltage/overvoltage

Function

FS-20

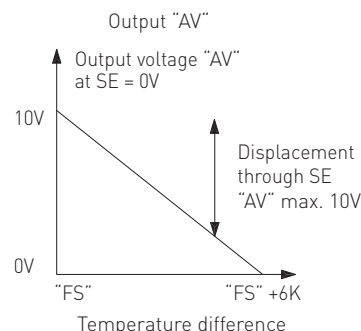
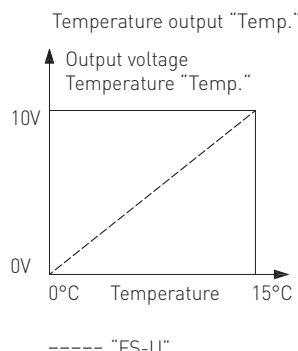
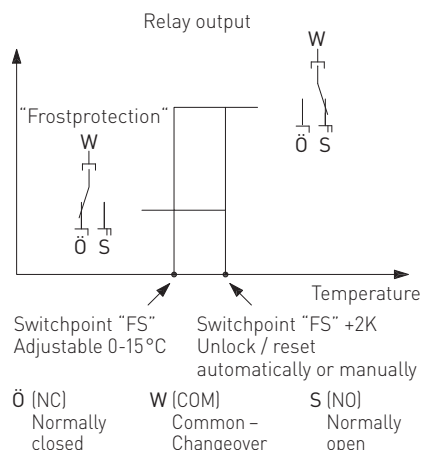

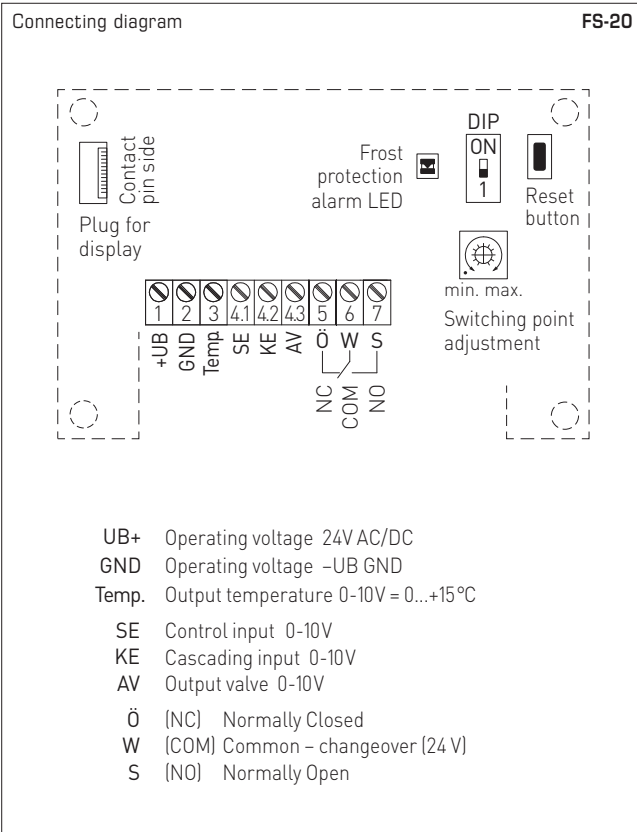

DIP switch FS-20	
Resetting after frost protection (Mode adjustable)	DIP 1
Reset Hand (manually) Alarm remains saved	ON
Reset Auto (automatically) Alarm is reset automatically (default)	OFF

THERMASREG® FS-20 Two-phase frost protection thermostats

Type / WG02	Measuring Range	Output	Sensor length	Display	Item No.
FS-20					
FS20-UW 3m LCD	0...+15 °C	2 x 0-10V, 1 x changeover contact	3,0 m	■	1102-1012-2102-030
FS20-UW 6m LCD	0...+15 °C	2 x 0-10V, 1 x changeover contact	6,0 m	■	1102-1011-2102-030
FS-20 xx HE with heating element					
FS20-UW-HE 3m LCD	0...+15 °C	2 x 0-10V, 1 x changeover contact	3,0 m	■	1102-1012-2112-030
FS20-UW-HE 6m LCD	0...+15 °C	2 x 0-10V, 1 x changeover contact	6,0 m	■	1102-1011-2112-030

ACCESSORIES		
KRD-04	Capillary tube gland bracket	7100-0030-7000-000
MK-05-K	Mounting clamps (6 pieces) plastic (included in the scope of delivery)	7100-0034-1000-000
WS-03	Weather and sun protection hood, 200 x 180 x 150 mm, stainless steel V2A (1.4301)	7100-0040-6000-000

For further information see last chapter!

